

Cleco

P2561MA-INT
REV B | 2024-02

CellTek™

AC(...)00-R0-G0-LD4



Copyright © 2024 Apex Brands, Inc. All rights reserved.

Disclaimer

Apex Tool Group reserves the right to modify, supplement, or improve this document or the product without prior notice.

Trademark

Cleco is a registered trademark of Apex Brands, Inc.

Apex Tool Group

670 Industrial Drive
Lexington, SC 29072
USA

Manufacturer
Apex Tool Group GmbH
Industriestraße 1
73463 Westhausen
Germany

CTBAW(...)

1

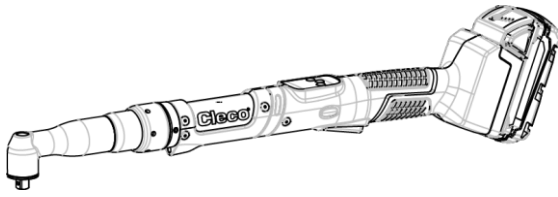

2

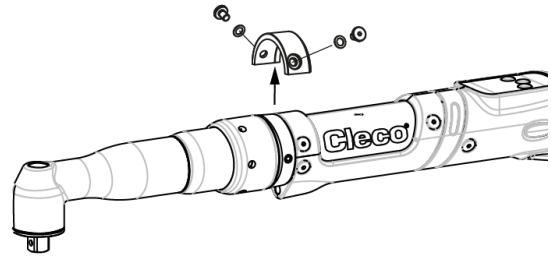

3

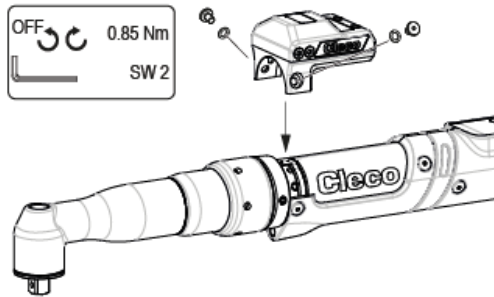

4

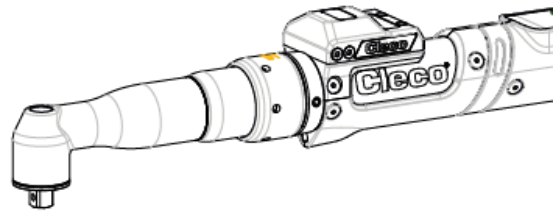

CTBPW(...)

1

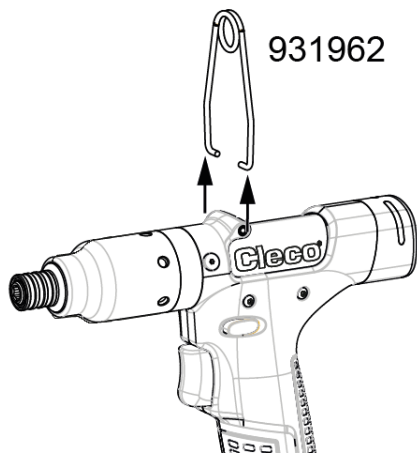

2

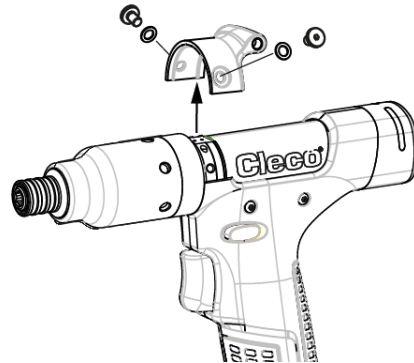

3

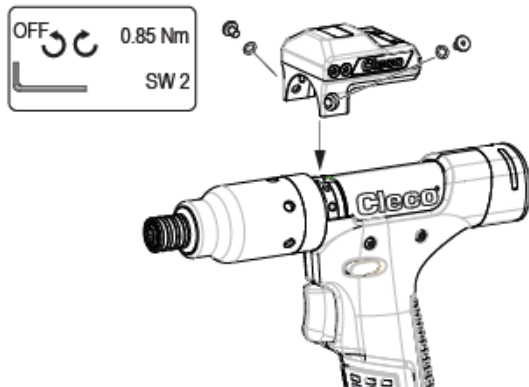

4

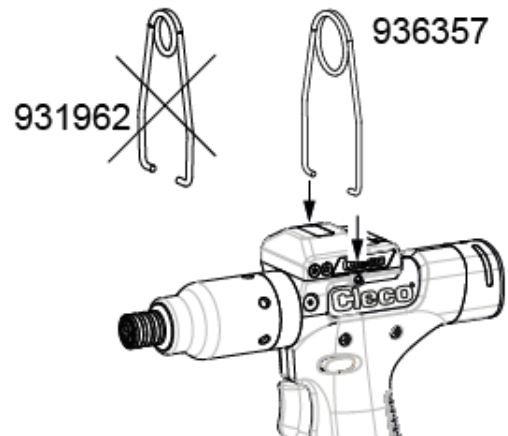

AC(...)00-R0-G0-LD4

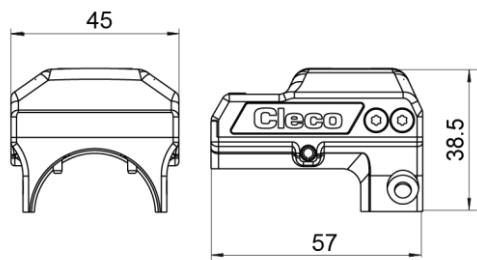
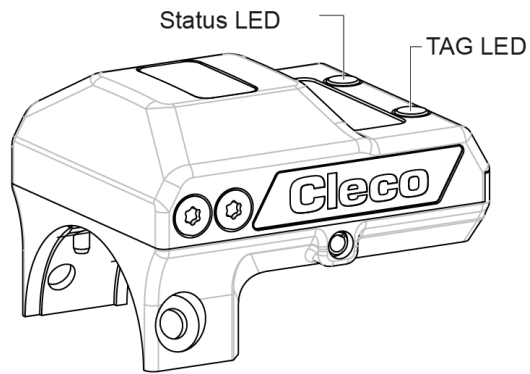

Nomenclature

Präfix	A	C	P A	00 SA	R0 R2 R3	G0 G1	L00 LD4 LSI LNA LKI
Accessory							
Tool Family	CellTek						
Tool Type	P – Pistol A – Angle Head						
Adapter Size	00 – No specific SA – Stay Alive						
Front Option	R0 – No Reader R2 – Reader 2D Matrix (Laser Aimer) R3 – Reader 2D Matrix (no Laser Aimer)						
Gyro Option	G0 – No Gyro G1 – Gyro						
Localisation	L00 – No TAG LD4 – Ubisense D4 LSI – SIMATIC RTLS LNA – NATEV LKI – KINEXON						

Content

EN

1	About this Document	7
2	Software Requirements	7
3	Product Description	7
4	Installation	7
5	Activating accessories	7
6	LED Display	7
7	Ambient conditions	7
8	Troubleshooting	8

DE

1	Zu diesem Dokument	9
2	Softwareanforderungen	9
3	Produktbeschreibung	9
4	Installation	9
5	Zubehör aktivieren	9
6	LED-Anzeige	9
7	Umgebungsbedingungen	9
8	Fehlersuche	10

1 About this Document

This document is intended for specialists in installation and maintenance (administrators, maintenance staff, service personnel, owners/operators). It contains information on safe and proper installation. The original language of this document is German.

Other Documents

Number	Document
P2544PM	Programming Manual – S169263 CTBA & CTBP

2 Software Requirements

- Bootloader: S169353-101 or later
- Controller: e.g., S168813-1.9 or later
- Measurement card: S169263-212 or later

3 Product Description



Tool	Module Order no.
Angle head	ACA00-R0-G0-LD4
Pistol	ACP00-R0-G0-LD4

The TAG module allows CellTek tools to be located within a position system.

4 Installation

Angle head: see figure see CTBAW(...), page 3.

Pistol: see figure see CTBPW(...), page 3.

	<p>Caution</p> <p>Winding hazard Unintentional pressing of the start trigger can cause the drive to turn and cause serious finger injuries.</p> <ul style="list-style-type: none"> ▶ Disconnect the tool from the power supply when converting work.
	<p>Note</p> <p>Malfunction Accessories can be initialized incorrectly at start-up if the tool was not completely switched off during installation.</p> <ul style="list-style-type: none"> ▶ Before installing, remove the battery and wait approx. 20 seconds for the tool to stop working.





5 Activating accessories

The accessory is active as soon as it has been installed. No additional activation is necessary. For further settings,



see the respective software documentation for the control and the documentation for the tool.

6 LED Display

Status LED

Color	Explanation
 Continuous green light	Ready
 Flashing yellow light	Initialization. If more than 20 seconds, see Troubleshooting.
 Continuous red light	See Troubleshooting.
 Continuous white light	Software update is running. Do not interrupt the power supply.

TAG LED

Color	Explanation
 Flashing light yellow	TAG active.
 Off	TAG not active, see Troubleshooting.

7 Ambient conditions

- EMC Limit Class A (electromagnetic immunity for industrial areas)
- Recommendation: ESD workstation on installation

Features	Data
Operation site	Indoors
Working temperature	0 °C – 45 °C
Storage temperature	-25 °C – 70 °C
Type of cooling	Convection (self-cooling)
Relative humidity	10 % – 90 %, no condensation
Working height	Up to 3 000 m (9,843 ft) above sea level
Degree of protection EN 60529	IP40

8 Troubleshooting

Problem	Possible cause	Measure
Module does not work	Tool not active	▶ Press the start switch on the tool
	Module not properly installed	▶ Check installation
	Module not activated by software	▶ Reattach the battery ▶ Restart tool
	Wrong software on tool	▶ Perform software update with correct software
	Tool defective	▶ Replace tool
	Module defective	▶ Replace module
Status LED: Flashlight yellow for longer than 20 seconds	Initialization of the module failed	▶ Reinsert the battery ▶ Restart the tool
	Module not properly installed	▶ Check assembly
	Software out of date	▶ Update CellTek Firmware see <i>software.apextoolgroup.com</i>
	Module defective	▶ Exchange module
	Tool defective	▶ Exchange tool
Status LED: Continuous red light after switching on	Initialization of the module failed	▶ Reattach the battery ▶ Restart tool
	Module defective	▶ Replace module
Status LED: Off after successful initialization	Power supply no longer active	▶ Press the start switch on the tool
TAG LED: No flashing light after initialization	Module does not communicate with the positioning system	▶ Check whether the tool is within the reception area

1 Zu diesem Dokument

Dieses Dokument richtet sich an Fachkräfte für Installation und Instandhaltung (Administratoren, Instandhalter, Service, Betreiber).

Es enthält Informationen zum sicheren und sachgerechten Einbau.

Die Originalsprache dieses Dokuments ist Deutsch.

Weiterführende Dokumente

Nummer	Dokument
P2544PM	Programmieranleitung – S169263 CTBA & CTBP

2 Softwareanforderungen

- Bootloader: S169353-101 oder neuer
- Steuerung: z. B. S168813-1.9 oder neuer
- Messkarte: S169263-212 oder neuer

3 Produktbeschreibung



Werkzeug	Modul Bestell-Nr.
Winkelkopf	ACA00-R0-G0-LD4
Pistole	ACP00-R0-G0-LD4

Das TAG Modul ermöglicht das Orten von Werkzeugen innerhalb eines Ortungssystems.

4 Installation

Winkelkopf: siehe Abbildung *siehe CTBAW(...), Seite 3.*

Pistole: siehe Abbildung *siehe CTBPW(...), Seite 3.*





	<p>Vorsicht</p> <p>Aufwicklungsgefahr Unbeabsichtigtes Betätigen des Startschalters kann zum Drehen des Antriebs führen und schwere Fingerletzungen verursachen.</p> <p>► Das Werkzeug bei Umrüstarbeiten von der Stromversorgung trennen.</p>
	<p>Hinweis</p> <p>Funktionsstörung Zubehör kann beim Start falsch initialisiert werden, wenn das Werkzeug bei der Installation nicht komplett ausgeschaltet war.</p> <p>► Vor der Installation den Akku entfernen und ca. 20 Sekunden warten, bis das Werkzeug außer Betrieb ist.</p>

5 Zubehör aktivieren



Das Zubehör ist aktiv, sobald es montiert wurde. Es ist keine zusätzliche Aktivierung notwendig. Weitere Einstellungen siehe jeweilige Softwaredokumentation der Steuerung sowie Dokumentation des Werkzeugs.

6 LED-Anzeige

Status LED

Farbe	Bedeutung
 Dauerlicht Grün	Bereit
 Blinklicht Gelb	Initialisierung. Wenn länger als 20 Sekunden, siehe Fehlersuche.
 Dauerlicht Rot	Siehe Fehlersuche.
 Dauerlicht Weiß	Software-Update läuft. Energieversorgung nicht unterbrechen.

TAG LED

Farbe	Bedeutung
 Blinklicht Gelb	TAG aktiv.
 Aus	TAG nicht aktiv, siehe Fehlersuche.

7 Umgebungsbedingungen

- EMV-Grenzwertklasse A (Störfestigkeit für Industriebereiche)
- Empfehlung: ESD Arbeitsplatz bei Installation

Merkmale	Daten
Einsatzort	In Innenräumen
Arbeitstemperatur	0 °C – 45 °C
Lagertemperatur	-25 °C – 70 °C
Kühlungsart	Konvektion (Eigenkühlung)
Relative Luftfeuchtigkeit	10 % – 90 %, keine Betauung
Arbeitshöhe	Bis 3 000 m über NN
Schutzart EN 60529	IP40

8 Fehlersuche

Problem	Mögliche Ursache	Maßnahme
Modul funktioniert nicht	Werkzeug nicht aktiv	▶ Startschalter am Werkzeug betätigen
	Modul nicht richtig montiert	▶ Montage prüfen
	Modul durch Software nicht aktiviert	▶ Akku neu stecken ▶ Werkzeug neu starten
	Falsche Software auf Werkzeug	▶ Software-Update mit richtiger Software durch führen
	Werkzeug defekt	▶ Werkzeug tauschen
	Modul defekt	▶ Modul tauschen
Status LED: Blinklicht Gelb länger als 20 Sekunden	Initialisierung des Moduls fehlgeschlagen	▶ Akku neu stecken ▶ Werkzeug neu starten
	Modul nicht richtig montiert	▶ Montage prüfen
	Software nicht aktuell	▶ Update CellTek Firmware siehe software.apextoolgroup.com
	Modul defekt	▶ Modul tauschen
	Werkzeug defekt	▶ Werkzeug tauschen
Status LED: Dauerlicht Rot nach Einschalten	Initialisierung des Moduls fehlgeschlagen	▶ Akku neu stecken ▶ Werkzeug neu starten
	Modul defekt	▶ Modul tauschen
Status LED: Aus nach erfolgreicher Initialisierung	Spannungsversorgung nicht mehr aktiv	▶ Startschalter am Werkzeug betätigen
TAG LED: Kein Blinklicht nach Initialisierung	Modul kommuniziert nicht mit Ortungssystem	▶ Prüfen, ob sich Werkzeug innerhalb des Empfangsbereichs befindet

POWER TOOLS SALES & SERVICE CENTERS

Please note that all locations may not service all products.

Contact the nearest Cleco® Sales & Service Center for the appropriate facility to handle your service requirements.

 Sales Center



 Service Center

NORTH AMERICA | SOUTH AMERICA

DETROIT, MICHIGAN

Apex Tool Group
2630 Superior Court
Auburn Hills, MI 48236
Phone: +1 (248) 393-5644
Fax: +1 (248) 391-6295

LEXINGTON,

SOUTH CAROLINA  
Apex Tool Group
670 Industrial Drive
Lexington, SC 29072
Phone: +1 (800) 845-5629
Phone: +1 (919) 387-0099
Fax: +1 (803) 358-7681

MEXICO

Apex Tool Group
Vialidad El Pueblito #103
Parque Industrial Querétaro
Querétaro, QRO 76220
Mexico
Phone: +52 (442) 211 3800
Fax: +52 (800) 685 5560

EUROPE | MIDDLE EAST | AFRICA

FRANCE

Apex Tool Group SAS
25 Avenue Maurice Chevalier - ZI
77330 Ozoir-La-Ferrière
France
Phone: +33 1 64 43 22 00
Fax: +33 1 64 43 17 17

GERMANY

Apex Tool Group GmbH
Industriestraße 1
73463 Westhausen
Germany
Phone: +49 (0) 73 63 81 0
Fax: +49 (0) 73 63 81 222

HUNGARY

Apex Tool Group
Hungária Kft.
Platánfa u. 2
9027 GyőrHungary
Phone: +36 96 66 1383
Fax: +36 96 66 1135

ASIA PACIFIC

AUSTRALIA

Apex Tool Group
519 Nurigong Street, Albury
NSW 2640
Australia
Phone: +61 2 6058 0300

CHINA

Apex Power Tool Trading
(Shanghai) Co., Ltd.
2nd Floor, Area C
177 Bi Bo Road
Pu Dong New Area, Shanghai
China 201203 P.R.C.
Phone: +86 21 60880320
Fax: +86 21 60880298

INDIA

Apex Power Tool Trading
Private Limited
Gala No. 1, Plot No. 5
S. No. 234, 235 & 245
Indialand Global
Industrial Park
Taluka-Mulsi, Phase I
Hinjawadi, Pune 411057
Maharashtra, India
Phone: +91 020 66761111

JAPAN

Apex Tool Group Japan
Korin-Kaikan 5F,
3-6-23 Shibakoen, Minato-Ku,
Tokyo 105-0011, JAPAN
Phone: +81-3-6450-1840
Fax: +81-3-6450-1841

KOREA

Apex Tool Group Korea
#1503, Hibrand Living Bldg.,
215 Yangjae-dong,
Seocho-gu, Seoul 137-924,
Korea
Phone: +82-2-2155-0250
Fax: +82-2-2155-0252

Cleco

Apex Tool Group, LLC

Phone: +1 (800) 845-5629

Phone: +1 (919) 387-0099

Fax: +1 (803) 358-7681

www.ClecoTools.com

www.ClecoTools.de